

PRESSURE GAUGE AND XMTR. MOUNTING DETAIL.

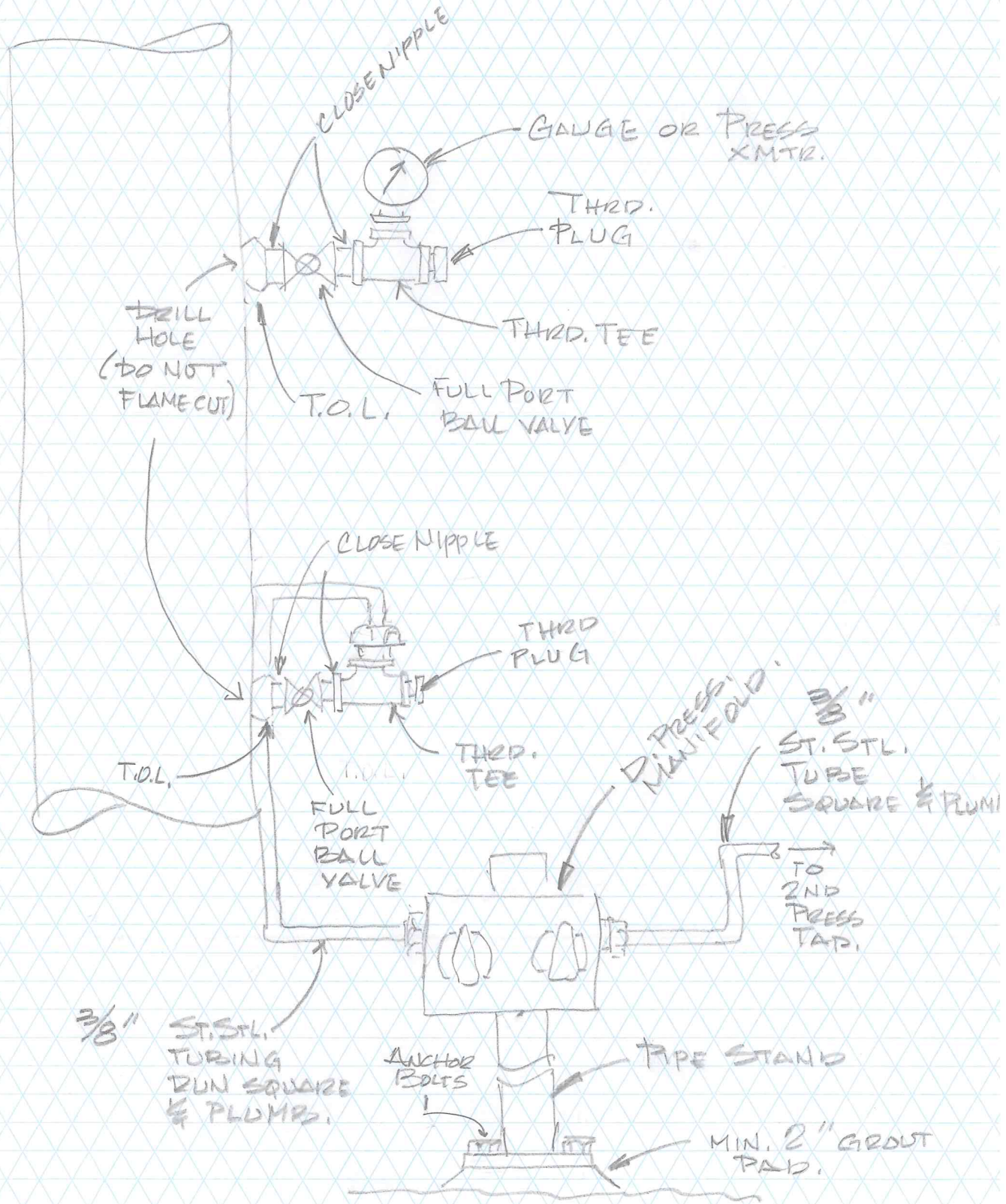

TEMP GAUGE & TEMP XMITTR DETAIL

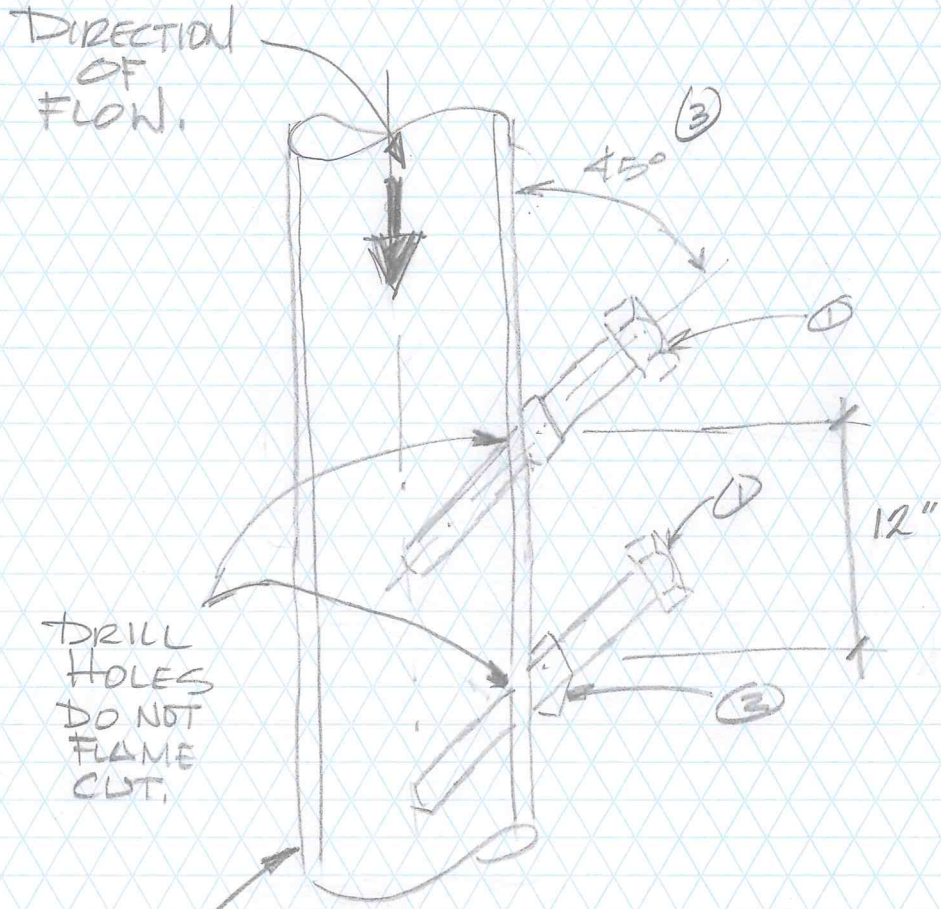

VERTICAL

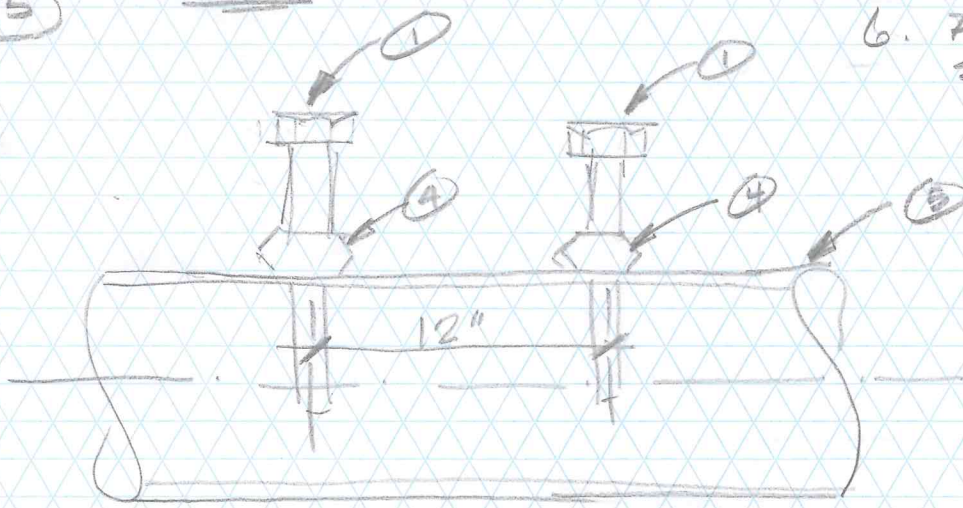

HORIZONTAL

LEGEND

- ① ST. STL. THERMOWELL EXTENDS TO MID-LINE OF PIPE. USE EXTENDED NECK FOR INSULATED PIPE.
- ② 45° DEG. T.O.L.
- ③ FOR VERTICAL PIPE, THERMOWELLS SHALL BE ORIENTED HOLD LIQUID.
- ④ STANDARD T.O.L.
- ⑤ 4" OR LARGER DIA. PIPE.
6. ALL TEMP DEVICES SHALL BE ORIENTED TO TOUCH BOTTOM OF OUTLET.

TEMP GAUGE & TEMP XMTR DETAIL

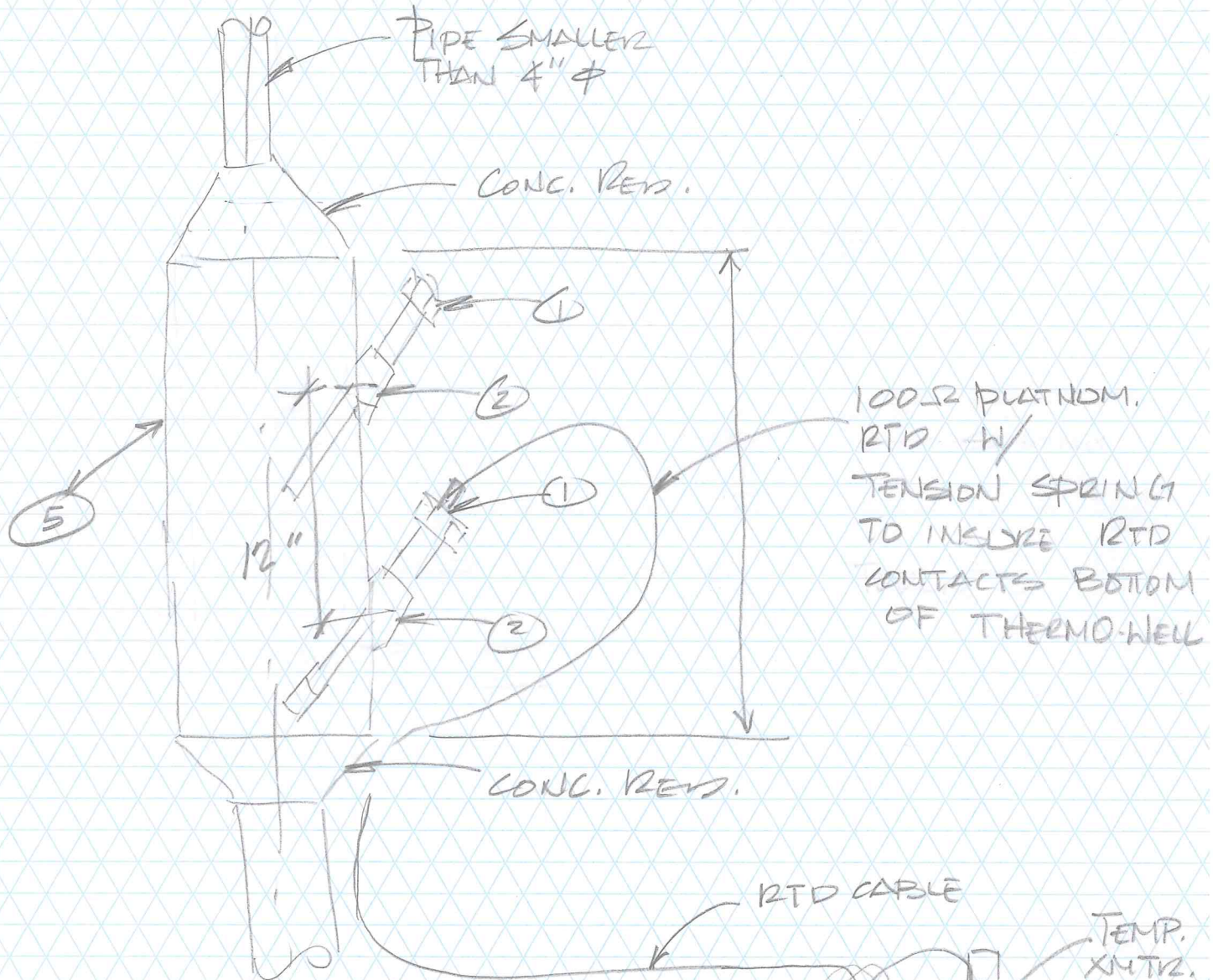

MOUNTING DETAIL
FOR PIPE LESS THAN 4" ϕ

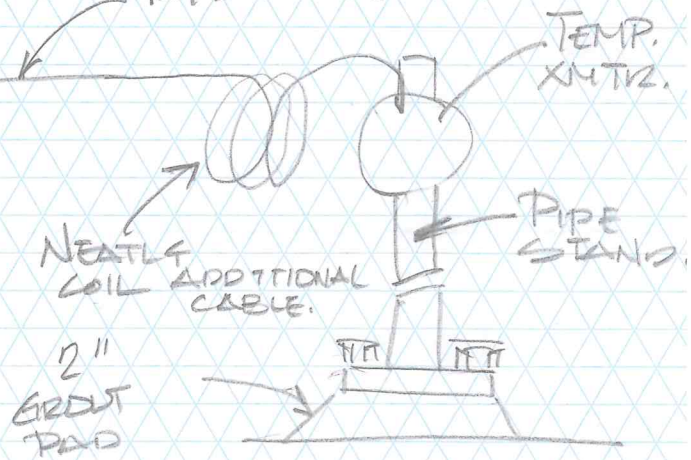

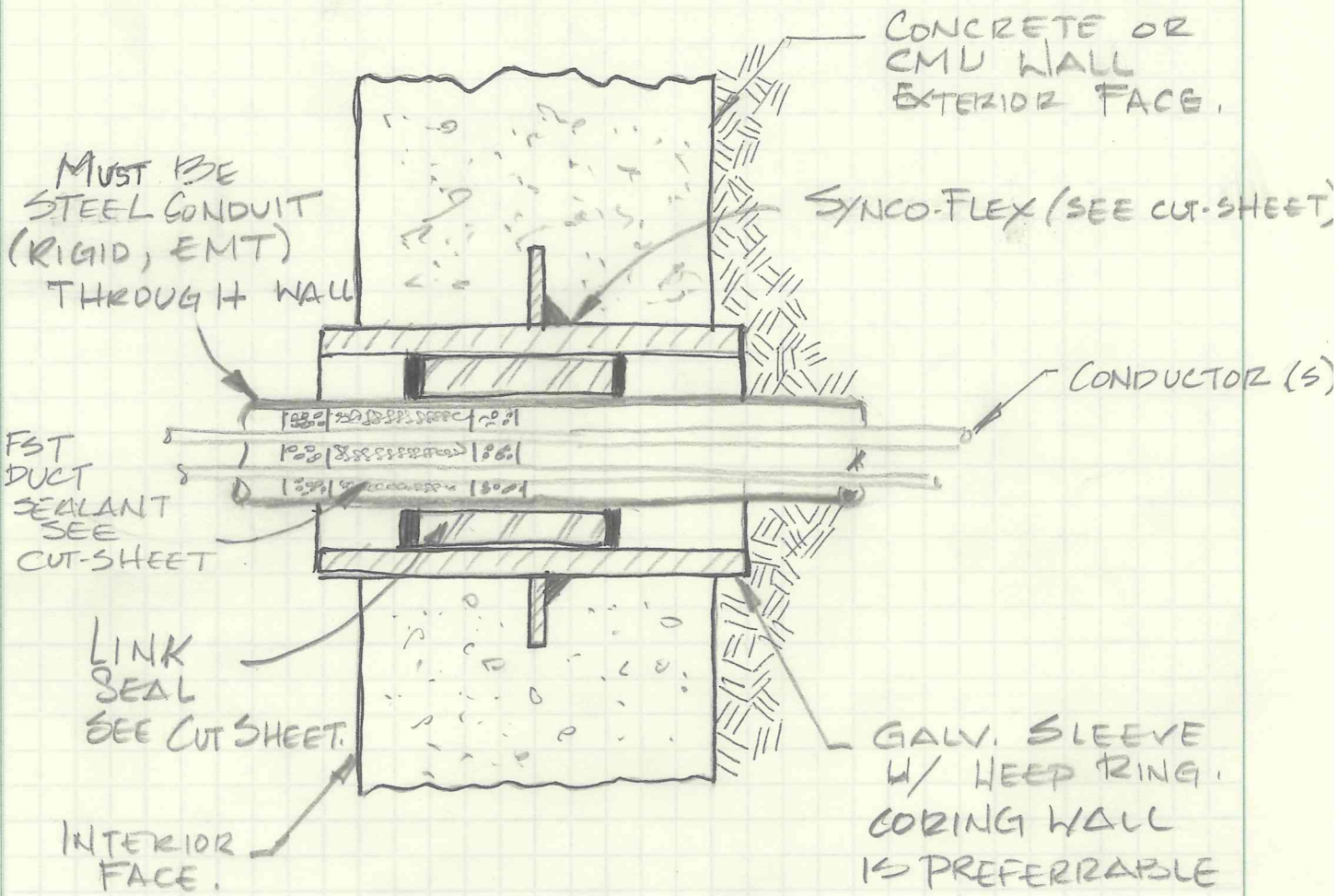

CONDUIT WALL PENETRATION DETAIL

TYP. SEE ADDITIONAL
DETAIL FOR DRIP-PROOF

DRIP-PROOF WALL PENETRATION

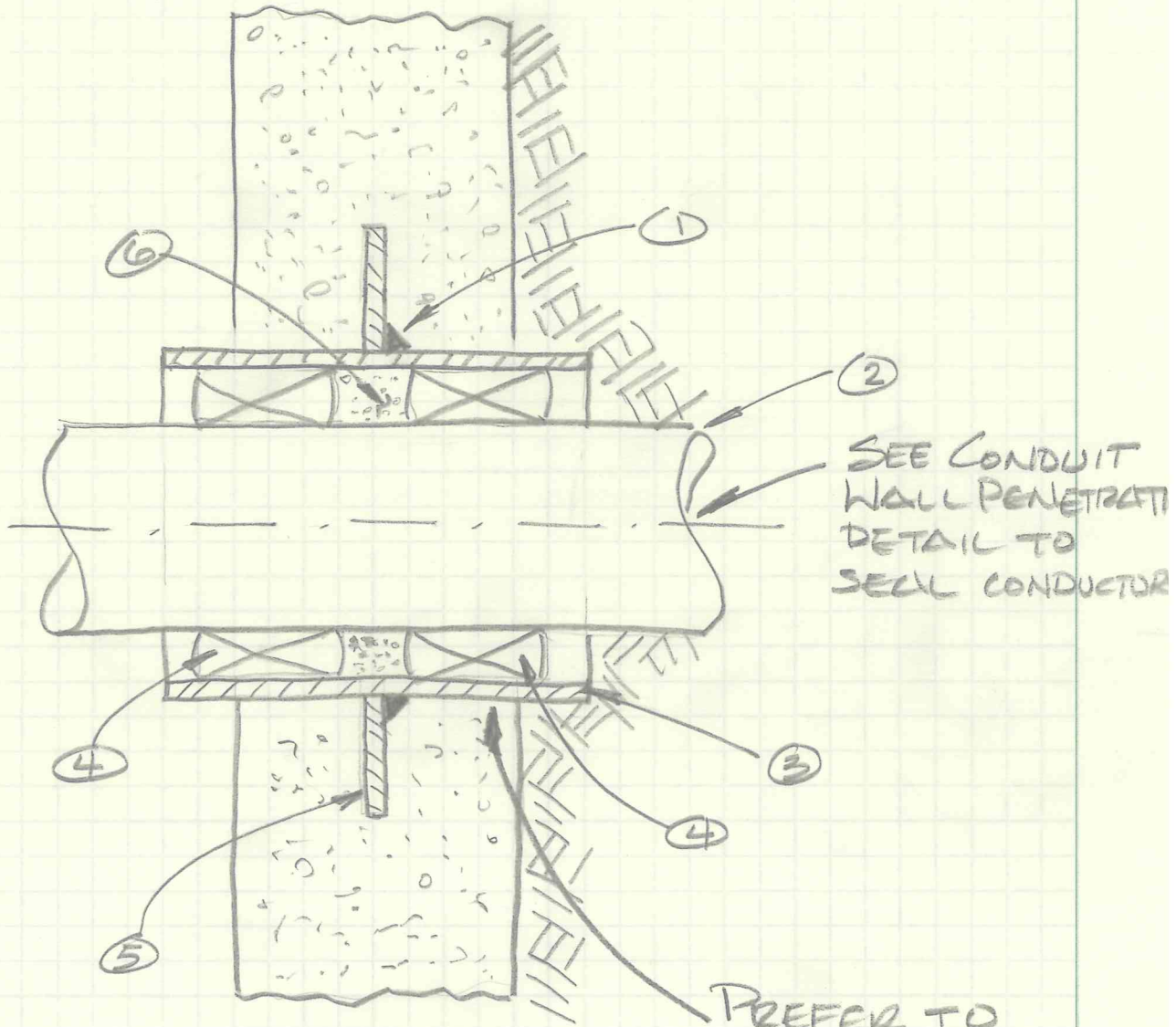

LEGEND

- ① SYNKO-FLEX
- ② HARD PIPE OR CONDUIT
- ③ GALV. SLEEVE
- ④ LINK-SEAL
- ⑤ WEEP RING
- ⑥ HYDRO-PHYLLIC MATERIAL (LOW EXPANSION RATIO)

FST™ Foam Sealant

American
Polywater
Corporation

TECHNICAL DATA SHEET

Description:

FST™ Sealant is a two-part, high-expansion foam duct sealant. It keeps water, acids, dust, gases, insects, and rodents out of the duct. FST™ Sealant expands and hardens to a “closed cell”, rigid structure. This permanent, but removable, seal blocks both water and gas under moderate pressure.

FST™ Sealant comes in a multi-use single plunger caulking tube package. The foam wets and adheres to metals, plastics, and concrete, and can seal ducts of different sizes, base materials, and shapes. It will conform around complex cable fill configurations. A kit contains everything required to install the duct block (application tool available separately).

Water Blockage:

FST™ Sealant is an excellent water block. To test water blocking performance, it is installed into a conduit according to standard procedures, forming a 3-inch plug. Water is added to the system and then pressurized to create a “water-head”.

Condition

Result

HDPE Duct, (SDR 13.5) No Cables	Holds 7 days at 30 psi (70 feet of water)
PVC Conduit, No Cables	Holds 450 days at 10 psi (22 feet of water)
PVC Conduit, 3 MDPE Cables	Holds 15 min at 40 psi (90 feet of water)
PVC Conduit, 3 MDPE Cables <i>bent</i> 45°, opposite directions for 5 minutes	Holds 15 min at 40 psi (90 feet of water)
PVC Conduit, 3 MDPE Cables <i>pulled</i> with 15 lbs axial force for 4 hours	Holds 15 min at 40 psi (90 feet of water)

FST™ Sealant blocks considerable water-head pressure, even when forces are placed on the cable to stress the seal.



The FST™ Sealant comes in a caulking style (one plunger) tube. Package allows multiple seals. Mixing is done in the nozzle as the sealant is injected.

Product Benefits:

- Meets 2011 NEC Articles 225.27, 230.8, and 300.5(G) Raceway Seals
- Creates a strong, resilient, chemically resistant seal
- Holds 20 feet water-head pressure continuous; 70 feet water-head intermittent
- Expands, cures and seals even when water is present
- Controlled injection quantity – no waste
- Seal tolerates cable movement and environmental extremes
- Compatible with common cable and wire jackets
- Single cartridge can seal multiple ducts
- Re-enterable – seal can be removed

Official Approvals:

- UL Recognized
Passes UL94
Class HBF fire retardant rating



Component Properties:

FST™ Sealant is a two-part, urethane foam. The liquid Part A and B are formulated to be mixed at a 1/1 ratio using the two-part coaxial caulking tube with the static mixing nozzle provided.

<u>Property</u>	<u>Part A (Resin)</u>	<u>Part B (Curing Agent)</u>
Color	Amber	Clear
Form	Liquid 250 cps	Liquid 650 cps
VOC Content:	0 g/L	0 g/L
Specific Gravity	1.2	1.1

Cured Properties:

FST™ Foam Sealant cures to solid, closed-cell foam.

<u>Property</u>	<u>Typical Result</u>
Appearance	Light yellow color with small, even cells
Closed Cell Percent	98%
Density	6 lbs/cu. ft.
Compressive Strength (ASTM D1691)	330 psi
Tensile Strength (ASTM 1623)	270 psi
Flexural Strength (ASTM D790)	460 psi
Seal Strength - Water	70 feet intermittent 20 feet continuous
Seal Strength - Air	>5 psi

Seal Strength - Air and Other Gases:

FST™ Sealant can seal out manhole gases. To test seal strength, a 3-inch FST™ seal is installed into conduit according to standard directions. The conduit is sealed and pressurized with both air and helium. Helium is a small molecule, less than half the size of methane gas, and was used in place of methane.

<u>Condition</u>	<u>Result</u>
Air, 10 psi, 168 hours	Holds Seal
Helium, 5 psi, 72 hours	Holds Seal

The FST™ Sealant closed cell foam will block air and other gases for an extended period of time.

Cable Removal/Theft Deterrent Testing

FST™ Sealant acts as a theft deterrent by sealing cables into the conduit. To test this, a 3-inch plug of FST is used to seal 3 cables in a conduit according to standard procedures. The force to pull out each cable is measured.

<u>Cable Type</u>	<u>Average Pull Out Tension (lb_f)</u>
2 AWG THHN	171
4/0 XHHW	320

<u>Draka prelubricated HDPE Cable in Conduit (CIC)</u>	<u>Average Pull-Out Tension (lb_f)</u>
1-¼ inch with (2) RHW-2 awg cables and ground	188*
1-½ inch with (3) RHW-2 awg cables and ground	179*

*Entire foam core pulled out of the conduit.

FST™ Sealant increases the cable holding force, making removal by hand very difficult.

Cable Compatibility

FST™ Sealant is compatible with common cable jacket materials. It does not change physical or electrical property of cable, based on tensile - elongation and volume resistivity testing. The cured foam is an inert solid that does not affect cable components.

Chemical Resistance

FST™ Sealant is chemically resistant to gasoline, oils, dilute acids and bases, and most unsaturated hydrocarbons.

Environmental Resistance:

FST™ Sealant withstands the rigors of the conduit exposure environment.

Cured Sealant Temperature Use Range
-20° F to 200° F (-29° C to 93° C) Continuous
-40° F to 250° F (-40° C to 121° C) Peak

FST™ Sealant does not lose function in direct sunlight. Reacted foam that is exposed to uv will yellow. This discoloration does not affect performance, the foam seal retains its hardness and continues to act as a duct block.

The foam sealant can be protected with a weather proofing paint. Both urethane and epoxy based products have been tested with good results and excellent adhesion to the foam.

Application:

Field-Ready Kit

The FST™ Sealant kit includes all materials required to install a finished duct block.

Seal Length

It is most important to make a seal of adequate length by using and properly spacing the damming strips. A 3-inch plug will meet performance guidelines.

Application Temperature

Working temperature for Polywater® FST™ Sealant is 35° F to 95° F (2° C to 35°C).

Water in Duct

FST™ Sealant will cure and seal duct with small amounts of water present. The water should not be flowing, and should be relatively clean. The FST™ foam will incorporate water into its cure. However, excessive water will weaken the seal.

For full installation information, please see the [FST™ Installation Instructions](http://www.polywater.com/FSTuse.pdf).
(www.polywater.com/FSTuse.pdf)

Cure Rate:

The FST™ Sealant can be used in temperatures down to 35° F (2° C). At low temperatures, the reaction is slow, but the sealant will completely foam and cure with time. At cold temperatures, the sealant components become more viscous and flow through the mixing nozzle at a slower rate. Cure times are as follows:

	Reaction Time (Minutes)	
	40° F (4° C)	70° F (21° C)
Foaming, Expansion Complete	8 - 9	4 - 5
Hard, Non-sticky Skin Formation	15 - 18	7 - 9

Once a skin has formed, the foam may be visually inspected to determine whether the seal has completely filled the void. After the sealant has cured, the positioning rod or a screwdriver can be used to check for voids in the finished seal.

To decrease cure time in cold temperatures, warm FST™ Sealant cartridges prior to use.

Clean-up

Any unreacted material may be cleaned from surfaces with a solvent wipe such as Polywater's Type HP™ Cleaner/Degreaser. The part A amber resin will react with water if surfaces are washed with a soap and water solution. Once reacted, the foam has strong adhesion, and may be scraped or cut from surface.

Removal:

FST™ Sealant can be mechanically removed with some effort. Use a long screwdriver to puncture holes throughout the seal. With a hammer, punch the screwdriver through the foam, twist it to enlarge the cavity, and pull out. Once the foam is weakened, it can be chipped away, and the cable should break free.

Safety:

FST™ Sealant is a two-part urethane foam containing reactive chemicals. Polyurethanes are common in the construction industry and have been used for many years. Some individuals may become sensitized to components in the unreacted resin. Precautions must be observed during use and handling of these materials.

The use of FST™ in the prepackaged cartridge controls and reduces exposure. Once reacted, the foam is solid, closed-cell polyurethane. The finished product may be considered non-toxic. See MSDS for more information.

Combustion of Cured Foam

Irritating and toxic smoke and vapors may form during combustion of cured FST™ Foam Sealant. If burning the sealant material cannot be avoided, provide appropriate ventilation/respiratory protection against decomposition products during flame cutting operations.

Storage and Handling:

Keep containers cool, dry and away from sunlight. Leave cartridges in the protective foil pouch until ready to use/reuse.

Product shelf life is one year. Shelf life is one month after the product is opened.

Model Specification:

The statement below may be inserted into a customer specification to help maintain engineering standards and ensure work integrity.

The foam duct sealant shall be FST™ Sealant. The foam duct sealant shall be a two-part "blown" urethane foam with 98% closed cell content. The foam duct sealant shall have a compressive strength of 300 pounds (ASTM D1691), and shall have a tensile strength of 250 pounds (ASTM D1623). The foam duct sealant shall have a flexural strength of 450 pounds (ASTM D790), and shall withstand temperatures from -20° F to 200° F. The foam duct sealant shall be chemically resistant to gasoline, oils, dilute acids and bases.

The foam duct sealant shall be available as a kit suitable for sealing various sized ducts. The product shall foam and react in five to ten minutes at 70° F.

When installed, the sealant shall be capable of holding 10 psi water pressure continuously (equivalent of 22 feet water-head pressure).

Order Information:

<u>Cat #</u>	<u>Package Description</u>
FST-250 (12 units/case)	8½-oz two-part Foam Sealant caulking tube style with resealing cap 1 ea Static mixing nozzle
FST-250KIT1 (1 unit/case)	8½-oz two-part Foam Sealant caulking tube style with resealing cap 3 ea Static mixing nozzles 4 ea 24-inch Foam damming strips
FST-250KIT (6 units/case)	1 24-inch Abrasive strip 1 pair Disposable gloves 1 Position rod 1 Pre-treating wipe 1 Instruction sheet
TOOL-250 (1 unit/case)	Ratchet application tool for FST-250
FST-10NOZZLE (1 unit/case)	Mixing nozzle 10-pack (for FST-250)
FST-MINI-1 (1 unit/case)	50-ml two-part Foam Sealant, dual cartridge with resealing cap 3 ea Static mixing nozzles 6 ea Foam plugs
FST-MINI-B6 (6 units/case)	1 pair Disposable gloves 1 Instruction sheet
TOOL-50-11 (1 unit/case)	Dispensing tool for 50-ml cartridge, FST-MINI
FST-DAM (24 units/case)	24-inch Foam damming strip

***Custom kits available. Call factory for details.*

Quantity Calculator located online:

<http://www.polywater.com/calculators/fstcalculator.asp>

Copyright © 2013. American Polywater Corporation. All Rights Reserved

Important Notice: The statements here are made in good faith based on tests and observations we believe to be reliable. However, the completeness and accuracy of the information is not guaranteed. Before using, the end-user should conduct whatever evaluations are necessary to determine that the product is suitable for the intended use.

American Polywater expressly disclaims any implied warranties and conditions of merchantability and fitness for a particular purpose. American Polywater's only obligation shall be to replace such quantity of the product proven to be defective. Except for the replacement remedy, American Polywater shall not be liable for any loss, injury, or direct, indirect, or consequential damages resulting from product's use, regardless of the legal theory asserted.

Lit-FSTTech/2-13/GH/(2-13)

Makers of Polywater® and Dyna-Blue® Cable Lubricants
and Pull-Planner™ Software

**American
Polywater®
Corporation**

P.O. Box 53
Stillwater, MN 55082
U.S.A.
1-800-328-9384
1-651-430-2270

<http://www.polywater.com> (URL)

custserv@polywater.com (e-mail)

Polywater® Duct Sealant (FST-250)

Instructions for Use

FST-kit contents:

Foam Base Cartridge (in protective pouch)
Mixing Nozzles (in protective pouch/kit bag)
Positioning Rod

Foam Strips
Pair Protective Gloves
HP Cleaning Wipe



UL Recognized
Sealant

See alternate Saturated Dam Method for specialty applications such as running water, vertical conduit, or other complex/unusual geometries.

Installation Tips

- *Conduit cleaning and preparation is key to a good seal.*
- *Rapid injection will produce better mixing.*
- *For large ducts, use multiple injections. See Quantity Recommendation. (Page 3)*
- *Mixing nozzle is reusable 7-10 minutes after injection.*



*Clean duct with wire brush,
solvent wipe.*



*Separate cable(s) then wrap
with foam strip.*



Insert foam 5 inches

- 1.) If conduit has loose debris or rust, use a wire brush to remove all loose material. Abrade the surfaces with sand paper or steel wool to increase the effectiveness of the FST Sealant.

Clean cable(s) and duct with Type HP cleaning wipe (cat. # HP-P158ID) as provided in the kit. This will remove contaminants and any organic residue.

Note: Steel type conduit must be sanded and cleaned.

- 2.) Create a foam dam by loosely wrapping foam strip around cable(s) so that it fills the space between the cable(s) and duct. It should be slightly wider than duct and compress slightly when inserted. (If more than one cable, separate cables with foam strip.)

Tail end of foam strip should be at top of wrap. Foam strip will slow any existing water flow and contain the FST Sealant. Cut foam to size as necessary.

- 3.) Using the positioning rod, push foam 5 inches (125 mm) into duct. Make sure there are no voids in the foam dam for FST Sealant to flow through.

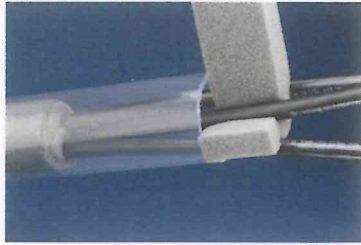

Separate cable(s) with foam



Prepare cartridge



TOOL-250 contains FST-250



Dispense Foam Sealant



Rising Foam

- 4.) Wrap the second foam strip around cable. (If more than one cable, separate cables with foam strip.) Tail end of foam strip should be at top of wrap. Push second foam strip into the duct until the edge is flush with the duct entrance.
- 5.) Remove Foam Cartridge from pouch. NOTE: Do not remove cartridge from protective foil until ready to use. Wear impermeable gloves and eye protection. **Holding cartridge upright**, remove nut and plug. (Plug can be saved for re-use of cartridge.) Attach mixing nozzle and tighten nut back into place. **Nut must be replaced or mixing nozzle will detach from cartridge and material may spill.**
- 6.) Use a **heavy-duty**, high-ratio caulking tool for best performance, (Cat. # TOOL-250). Dispense and discard the first liquid to run through the nozzle (about 1 squirt with the application tool). This initial material will not be well mixed or have the proper ratio of material.
- 7.) Insert mixing nozzle into top wrap of foam dam so that tip extends into space between foam strips. Inject sealant above cables for better coverage. Use desired amount of foam sealant (see Table 1).
Rapid injection will produce better mixing.
For large ducts, use multiple injections.
- 8.) Remove cartridge with the static mixer attached. Sealant may seep between the crevices of the foam dam as it expands. After cure, excess foam may be trimmed and removed.

Sealant will expand fully in 2 to 5 minutes.

Sealant will harden (set) in 10-15 minutes.

Mixing nozzle is reusable 7-10 minutes after injection.

Duct Size, O.D. Inches/mm	Quantity Liquid Foam Sealant	
	0% Cable Fill	20% Cable Fill
2/50	1.5 cm <i>(1 injection)</i>	1 cm <i>(1 injection)</i>
3/75	3 cm <i>(1 injection)</i>	2.5 cm <i>(1 injection)</i>
4/100	2 + 2.5 cm <i>(2 injections)</i>	2 + 2 cm <i>(2 injections)</i>
5/125	3 + 4 cm <i>(2 injections)</i>	3 + 3 cm <i>(2 injections)</i>
6/150	3 + 3 + 4 cm <i>(3 injections)</i>	4 + 4 cm <i>(2 injections)</i>
8/200	4 + 4.5 + 4 + 4.5 cm <i>(4 injections)</i>	3 + 4 + 3 + 4 cm <i>(4 injections)</i>

Table 1

There are approximately 8.5 cm per FST-250 Cartridge. Use side markings to measure quantity by difference.



Use as a starting point only, actual required quantity will vary.

To seal large ducts (4 inch diameter or larger), inject the FST in parts. After each injection, **wait 5 minutes** for sealant to rise. Inject each portion as recommended. Excess material may squirt from the foam dam after adding the final portion.

*For small ducts
(1-1/2 inch diameter or smaller)
the FST-MINI is recommended.*



Use screwdriver to check for voids

- 9.) After sealant has fully set and cured, use the positioning rod or a screwdriver to check for voids in the FST Seal. Foam seal should be solid throughout the duct. If any holes or voids are detected in the inspection, use a screwdriver to cut into top of foam and enlarge a path for new material. Attach a new mixing nozzle and inject sealant directly into the void area.

Dispose of any excess material in accordance with local and national regulations.

Storage: FST Foam is sensitive to sun, water and heat. To keep the FST Foam up to a month after initial use, place the partial used cartridge into the foil bag and tape it shut. Place the foil bag in a dry cool dark place until ready to use.

FST Foam Seal Application and Use

Polywater® Foam Sealant FST cures to a strong, rigid closed-cell structure. It has excellent wetting and adhesion to metal, concrete and plastic surfaces. It holds 20 feet (6 meters) water-head, and acts as a barrier to smoke and air. It provides superior resistance to water, acids, greases and bases and most organic compounds. Performance and test results can be found in the FST Tech Data Sheet and Lab Reports.

Clogged/leaking cartridge

The small orifices in the cartridge tip may become clogged. Poke through and loosen hard material or crust with a wire. Material may be used as directed once the clog is cleared. If the back plugs are leaking, do not use cartridge.

Re-use and Clean-up

Cartridge can be reused for several weeks after initial use. Remove mixing nozzle and visually ensure that orifices are not blocked. Seal with replaceable plug and nut. When ready to use, remove end cap assembly and check to make sure orifices are clear of any hardened sealant. Attach a new, unused mixing nozzle, tighten nut and insert used cartridge into ratchet application tool.

Unreacted material may be cleaned from surfaces with a solvent wipe such as Polywater's Type HP Cleaner/Degreaser. Part A, amber resin will react with water if surfaces are washed with soap and water solution. Once reacted, material has strong adhesion, and may be scraped or cut from surface. For skin contamination, wash thoroughly with soap and water. See MSDS for further information.

Water in duct

FST Sealant will cure if the duct contains less than 10% water. If water is relatively clean and not flowing, the foam dam will work as a good block. FST Sealant will incorporate any excess water into the body of the cured foam seal. Too much water and/or contamination will weaken the seal.

For flowing water, use the saturated foam method. See alternative instructions or watch video.

Removal

FST Sealant produces a good, water-tight seal intended for permanent use. It can be mechanically removed with some effort. Use best practices and comply with the NEC by de-energizing equipment before any seal removal is attempted. Use a long screwdriver (7 inches/15 cms) to puncture holes $\frac{1}{4}$ to $\frac{3}{4}$ inch (0.5 to 2 cm) throughout the seal. With a hammer, push the screwdriver through the foam, twist it to enlarge cavity, and pull out. Go around the inside duct diameter to remove plug. Once the foam is weakened, material can be chipped away, and the cable should break free. At this time the cable can be removed or the remaining FST Foam can be detached from the cable.

Cold Weather Use

FST Sealant can be used in temperatures down to 40°F (4°C). Reaction is slower, but the sealant will completely foam and cure with time. At cold temperatures, the Foam Sealant (FST) becomes slightly viscous and flows through the mixing nozzle at a slower rate. Cure times are as follows:

	40° F (4° C)	70° F (21° C)
Foaming, Expansion Complete	8 - 9 Minutes	4 - 5 Minutes
Hard, Non-sticky Skin Formation	12 - 15 Minutes	7 - 9 Minutes

To decrease cure time in cold temperatures, keep FST Sealant cartridges warm prior to use.

Large voids

Seal should be inspected after installation. If voids or holes are discovered, additional FST Sealant may be added at any time. It will bond very well to existing, cured material. Use a screwdriver to cut into top of foam and enlarge a path for new material. Attach a new mixing nozzle and inject sealant directly into the void area. Dam the fill area if larger than 2 inches (50 mm).

Urethane safety

Irritating and toxic smoke and vapors may form during combustion of cured FST Foam Sealant. Hazardous or irritating decomposition products include oxides of carbon, oxides of nitrogen and hydrogen cyanide. If possible, remove cured sealant prior to any torch cutting operations. The Sealant can usually be removed from the conduit using chisel style tool or pick. If burning the sealant material cannot be avoided, provide appropriate ventilation/respiratory protection against decomposition products during flame cutting operations.

Cable Compatibility

FST Foam is compatible with cable jacket materials. The foam is an inert solid that will not attack the jacket material.

Web Support



Standard Installation Video



Saturated Foam Method Installation Video



Quantity Calculator

Important Notice: The statements and information here are made in good faith based on tests and observations we believe to be reliable. However, the completeness and accuracy of the information is not guaranteed. Before using, the end-user should conduct whatever evaluations are necessary to determine that the product is suitable for the intended use. The user assumes all risks and liability in connection with such use.

The statements contained herein are made in lieu of all warranties, express or implied, including, but not limited to, implied warranties of merchantability and fitness for a particular purpose, which warranties are hereby expressly disclaimed. American Polywater's only obligation shall be to replace such quantity of the product proven to be defective. Except for the replacement remedy, American Polywater shall not be liable for any loss, injury or damage, direct or indirect, arising from the use or the failure to properly use these products, regardless of the legal theory asserted. The foregoing may not be altered except by a written agreement by the officers of American Polywater Corporation.

Makers of Polywater® and Dyna-Blue® Cable Lubricants
and Pull-Planner™ Software

American
Polywater
Corporation

P.O. Box 53
Stillwater, MN 55082
U.S.A
USA 1-800-328-9384
TEL 1-651-430-2270
FAX 1-651-430-3634

<http://www.polywater.com>(URL) custserv@polywater.com(e-mail)

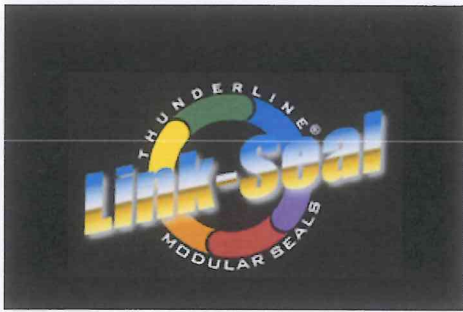

The system is the solution.

When you use Link-Seal® Modular Seals in combination with Century-Line® Sleeves, Cell-Cast® Disks or WS Steel Sleeves - you are creating the optimal situation, with engineered products designed to be used together, for quickly and easily creating a permanent seal between a cylindrical object and the barrier through which it passes.



- [Link-Seal® Modular Seals](#)
- [Century-Line® Sleeves](#)
- [Cell-Cast® Disks](#)
- [WS Steel Sleeves](#)
- [Seal-Finder™](#)
- [Distributor Locator](#)
- [Literature \(PDF\) Downloads](#)
- [Distributor Intranet](#)

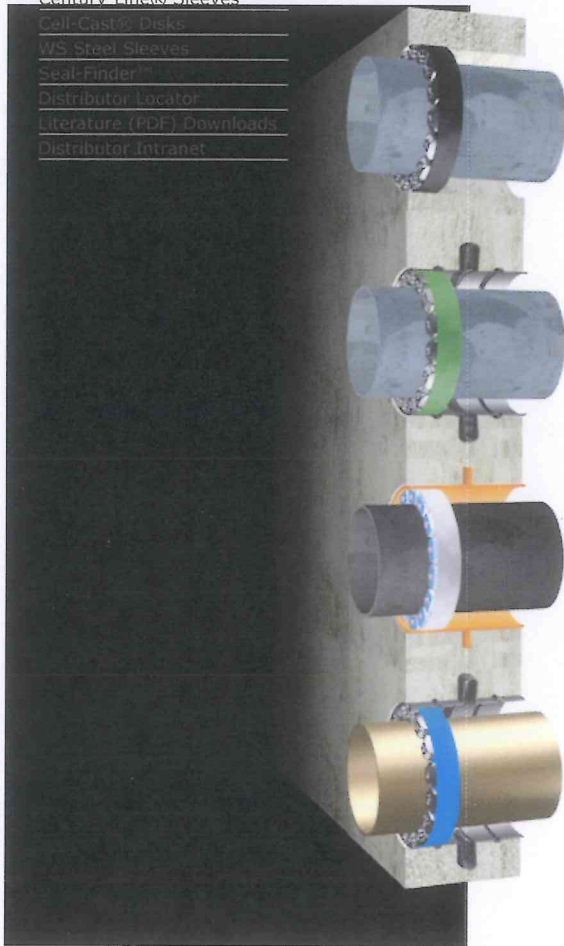

Link-Seal® Modular Seals, Model "C" (EPDM) installed in a cored hole.

The Model "C" is suitable for use in water, direct ground burial and atmospheric conditions. It also provides electrical isolation where cathodic protection is required. The Model "S-316" includes stainless steel hardware and is excellent for applications such as chemical processing and waste water treatment. EPDM rubber is resistant to most inorganic acids and alkalis, some organic chemicals (acetone, alcohol, ketones).

Link-Seal® Modular Seals, Model "O" (Nitrile) installed with a Century-Line® Sleeve

The Model "O" is resistant to oils, fuel and many solvents (gasoline, motor oil, kerosene, methane, jet fuel, hydraulic fluid, water, etc.). While resistant to normal atmospheric conditions, Nitrile is not U.V. resistant. Stainless steel hardware is available for highly corrosive environments. Century-Line® Sleeves are sized to match with Link-Seal® Modular Seals. It's the perfect combination to insure a leak proof (up to 20psi) seal seal - first time, every time.

Link-Seal® Modular Seals, Model "T" (Silicone) installed with a Model WS Steel Sleeve

The Model "T" is ideal for temperature extremes from -67°F. (-55°C.) to 400°F. (204°C.). In addition, the Model "T" is one-hour FM (Factory Mutual) approved. High temperature seals should be used with Model WS steel sleeves.

Link-Seal® Modular Seals, Model "L" (Low Durometer EPDM) installed with a Century-Line® Sleeve

The Low Durometer Model "L" is excellent for use with thin wall metal pipe, applications using plastic, ceramic or glass pipe - or applications where the cylindrical object is fragile and may not withstand the compressing forces generated by a standard Link-Seal® Modular Seal.



Link-Seal® Modular Seals || Century-Line® Sleeves || Cell-Cast® Disks
Seal-Finder® || Distributor Locator

Link-Seal®...the world's standard for sealing pipe penetrations passing through walls, floors and ceilings.



HOME



Description
Benefits/Features
Typical Applications
Seal and Hardware Options
Specifications
Warranty
How to Order
Installation

DESCRIPTION

Link-Seal® modular seals are considered to be the premier method for permanently sealing pipes of any size passing through walls, floors and ceilings. In fact, any cylindrical object may be quickly, easily and permanently sealed, as they pass through barriers, by the patented Link-Seal® modular seal design.

Ductile iron, concrete, metal as well as plastic pipes may be hydrostatically sealed within walls to hold up to 20 psig (40 feet of static head). Electrical or telecommunications cable may be sealed within conduit as they enter vaults or manholes. The annular space between carrier pipes passing through casings may be sealed against the entry of water, soil or backfill material.

With a wide variety of hardware/ elastomer combinations, Link-Seal modular seals are easily configured to achieve the best possible match for service conditions encountered. High temperature seals, fire seals (Factory Mutual Approved) and oil resistant seals may be ordered to meet special or unique service applications. For the system approach, metal or non-conductive Century-Line® sleeves with water stops may be ordered with Link-Seal modular seals to ensure correct positioning and a water tight seal of the installation within poured concrete walls.

Link-Seal modular seals are also available for a wide variety of special applications, temperature extremes, exotic chemical combinations and for "out of round" or non-centered applications. Please contact factory for your special application.



BENEFITS/FEATURES

Saves time and money...

- Link-Seal modular seals install in up to 75% less time compared to lead-oakum joints, hand fitted flashings, mastics or casing boots.

Positive hydrostatic seal...

- Link-Seal modular seals are rated at 20 psig (40 feet of head), which exceeds the performance requirements of most applications.

Long seal life...

- Link-Seal modular seals are designed for use as a permanent seal. Seal elements are specially compounded to resist aging and attack from ozone, sunlight, water and a wide range of chemicals.

Maximum protection against corrosion...

- Standard fasteners have a two-part zinc dichromate and proprietary corrosion inhibiting coating.

Certification/Approvals...

- Factory Mutual Fire Approvals.
- Also a wide variety of approvals from various Federal agencies, associations, code groups, laboratories and organizations.

ISO Quality Assurance...

- Link-Seal modular seals are manufactured in an ISO 9001:2000 certified facility.

Configure a Link-Seal modular seal to match your application...

- 16 sizes, color coded EPDM, Nitrile, & Silicone elastomers may be used with various hardware options to match performance characteristics with service conditions.



- Corrosion resistant 316 stainless steel available for maximum corrosion protection.

TYPICAL APPLICATIONS

Century-Line® Model CS Sleeves in Combination with “low durometer” EPDM (blue) Link-Seal® Modular Seals

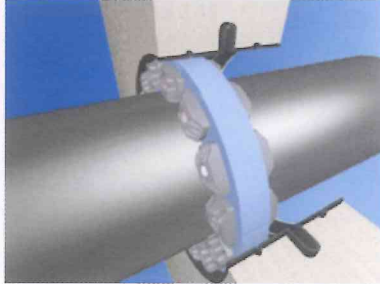

Century-Line® Model CS Sleeves are ideal for poured wall construction. Made of HDPE thermoplastic, they are lightweight and easy to handle. Molded-in waterstop and reinforcing ribs serve to anchor the sleeve in the wall and resist pour forces. Nailer end caps are provided to make placement in forms simple and accurate. Sleeves are available in 16 diameters, up to 25”, and any length. In the event of a field change they can be shortened with ordinary hand tools.

Pre-cast or Cored Wall Openings in Combination with Nitrile (green) Link-Seal® Modular Seals



Link-Seal® Modular Seals are also commonly installed in cored wall openings or pre-cast openings such as those formed by use of Cell-Cast® Disks for pipe penetration hole forms. See Cell-Cast Disk (page 4) or contact PSI for more information.

Model WS Steel Sleeves in Combination with Silicone (grey) Link-Seal® Modular Seals

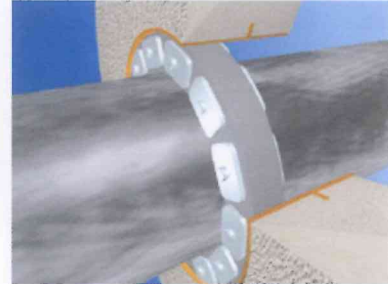

Model WS Steel Sleeves are made from heavy-wall welded or seamless pipe. A full circle waterstop plate acts as positive water seal and anchor to prevent thrust movement. The 2” collar (water-stop) is continuously welded on both sides. Model WS is available in a wide range of diameters and any length. Sleeves are protected by a coating of red primer. Hot dip galvanizing is available on request.

Typical Applications

- Mechanical Contractors - Interior Piping Systems
- Floor Sleeves
- Wall Sleeves
- Manhole Pipe Entry Seals
- Waste Treatment Plants
- Cased Road Crossings
- Elevator Shafts
- Power Generating Dams
- Thermal Storage Systems
- Fire Protection Wall Penetrations
- Cased Railroad Crossings
- Electrical Isolation of Pipes
- Precast Concrete Pipe Seals
- Insulated Pipe Seals
- Dual Containment Seals
- Marine Applications
- Noise Dampening
- Flexible Sign & Pole Supports
- Electrical Isolation of Pipe Supports for Corrosion Protection
- Mining
- Pulp & Paper
- Decorative Fountains
- Bank Tube Transfer Systems
- Pool Contractors
- Electrical Contractors
- Marine Applications
- Waste & Water Treatment
- Telecommunications
- Railway Crossings
- Valve Pits
- Refrigeration Buildings
- Overhead Signs
- Guard Post Assemblies
- Power Generation Dams
- Offshore Oil Rigs
- High Pressure Tank Guards
- Underground Steel Tanks
- Centuryline Applications
- Precast Concrete Manufacturers
- Perimeter Berm Installations Around Tank Farms
- Flow Restrictors in Sewer Maintenance
- Fluid Overflow Devices
- Noise and Sway Dampener
- Through Deck Fire Breaks
- Parking Garage Column Protectors
- Cable TV Installations
- Bridge Construction
- Septic Tank Installations
- Coal Preparation Plants
- Pile Driving Operations
- Flag Pole Installations
- Driving Contractors
- Tunneling Operations



LINK-SEAL® MODULAR SEAL AND HARDWARE OPTIONS



Model "C" or "L" Link-Seal Modular Seal

Suitable for use in water, direct ground burial and atmospheric conditions. Provides electrical insulation where cathodic protection

Type: Standard
Seal Element: EPDM (Black), EPDM (Blue)
Pressure Plates: Composite
Bolts & Nuts: Steel with 2-part Zinc

[Go To Ordering](#)

is required.
Color: Black or Blue

Dichromate & Proprietary Corrosion Inhibiting Coating

Temp. Range: -40 to +250F. (-40 to +121C.)*

* = Sustained operation near temperature limits may affect life expectancy.

[Go To Ordering](#)

Model "S-316" Link-Seal Modular Seal

For chemical processing waste water treatment. EPDM rubber is resistant to most inorganic acids and alkalis, some organic chemicals (acetone, alcohol, ketones).

Color: Black or Blue

Type: Stainless

Seal Element: EPDM (Black), EPDM (Blue)

Pressure Plates: Composite

Bolts & Nuts: 316 Stainless Steel

Temp. Range: -40 to +250F. (-40 to +121C.)*

* = Sustained operation near temperature limits may affect life expectancy.

[Go To Ordering](#)

Model "O" Link-Seal Modular Seal

Nitrile rubber is resistant to oils, fuel and many solvents (gasoline, motor oil, kerosene, methane, jet fuel, hydraulic fluid, water, etc.).

Color: Green

Type: Oil Resistant

Seal Element: Nitrile (Green)

Pressure Plates: Composite

Bolts & Nuts: Steel with 2-part Zinc

Dichromate & Proprietary Corrosion Inhibiting Coating

Temp. Range: -40 to +210F. (-40 to +99C.)*

* = Sustained operation near temperature limits may affect life expectancy.

[Go To Ordering](#)

Model "OS-316" Link-Seal Modular Seal

Combination of oil-resistant rubber and stainless steel hardware.

Color: Green

Type: Oil Resistant

Seal Element: Nitrile (Green)

Pressure Plates: Composite

Bolts & Nuts: 316 Stainless Steel

Temp. Range: -40 to +210F. (-40 to +99C.)*

* = Sustained operation near temperature limits may affect life expectancy.

[Go To Ordering](#)

Model "T" Link-Seal Modular Seal

Silicone rubber is ideal for temperature extremes. "T" model is Factory Mutual approved.

Color: Grey

Type: High/Low Temperature

Seal Element: Silicone (Grey)

Pressure Plates: Steel Zinc Dichromate

Bolts & Nuts: Steel with 2-part Zinc

Dichromate & Proprietary Corrosion Inhibiting Coating

Temp. Range: -67 to +400F. (-55 to +204C.)*

* = Sustained operation near temperature limits may affect life expectancy.

[Go To Ordering](#)

Model "FD/FS" Link-Seal Modular Seal

Double seal for added protection.

Color: Grey

Type: Fire Seals

Seal Element: Silicone (Grey)

Pressure Plates: Steel Zinc Dichromate

Bolts & Nuts: Steel with 2-part Zinc

Dichromate & Proprietary Corrosion Inhibiting Coating

Temp. Range: -67 to +400F. (-55 to +204C.)*

* = Sustained operation near temperature limits may affect life expectancy.



SPECIFICATIONS

Material Properties of Link-Seal Modular Seal Elements				
PROPERTY	ASTM METHOD	EPDM (EPDM L)	NITRILE	SILICONE
Hardness (shore A)	D-2240	50 ±5 (40 ±5)	50 ±5	50 ±5
Tensile	D-412	1450 psi	1300 psi	860 psi
Elongation	D-412	400%	300%	250%
Compression Set	S-395	15% 22 hrs. @ 158°F (70°C)	45% 22 hrs. @ 212°F (100°C)	40% 22 hrs. @ 350°F (177°C)
Specific Gravity	D-297	1.10	1.15	1.40

Material Properties of Composite Pressure Plates		
PROPERTY	ASTM METHOD	VALUE
Izod Impact - Notched	D-256	2.05 ft-lb/in
Tensile Strength @ Yield	D-638	20,000 psi
Tensile Strength - Break	D-638	20,250 psi
Flexural Strength @ Yield	D-790	30,750 psi
Flexural Modulus	D-790	1,124,000 psi
Elongation, Break	D-638	11.07%
Specific Gravity	D-792	1.38
Moisture Content	--	0.18%



Bolt & Nut Specifications	
Standard: Carbon Steel	Carbon steel, zinc dichromated per ASTM B633 with an additional corrosion inhibiting proprietary organic coating. (passes 1470 hour salt spray test) Tensile Strength = 60,000 psi, minimum.
Option: Stainless Steel	ANSI Type = 316, Per ASTM F593-95 Tensile Strength = 85,000 psi, average.

Modular/Mechanical Seal and Sleeve Specification

Typical Specification

1.0 Penetration Seals

Use a modular, mechanical seal, consisting of rubber links shaped to continuously fill the annular space between the pipe and the wall opening. Link-Seal® pressure plates shall be molded of glass reinforced nylon. Hardware shall be mild steel with a 60,000 psi minimum tensile strength and 2-part Zinc Dichromate coating per ASTM B-633 and Organic Coating, tested in accordance with ASTM B-117 to pass a 1,500-hour

2.0 Sleeves and Wall Openings

A. For diameters up to 24.81" install molded non-metallic high density polyethylene sleeves (HDPE) with integral hollow, molded water-stop ring four inches larger than the outside diameter of the sleeve itself. End caps and reinforcing ribs, domestically manufactured in an approved ISO-9001:2000 facility. Century-Line® Sleeve as manufactured by Pipeline Seal & Insulator, Inc, Houston, TX., or engineered pre-

salt spray test (or 316 Stainless Steel). Coloration shall be throughout elastomer for positive field inspection. Each link shall have permanent identification of the size and manufacturer's name molded into the pressure plate and sealing element. The Contractor will submit to verify the modular seals are domestically manufactured at a plant with a current ISO-9001:2000 registration. Copy of ISO-9001:2000 registrations shall be a submittal item. PSI-Thunderline/ Link-Seal® Modular Seal as manufactured by Pipeline Seal & Insulator, Inc, Houston, TX, or pre-approved equal.

approved equal.
B. For openings from 29.25" to 64.74" in diameter, use a modular hole-forming system consisting of interlocking HDPE plastic discs, domestically manufactured in an ISO-9001:2000 facility. The system shall provide a round hole in conformance with Link Seal® Modular Seal sizing data. Cell-Cast® Hole Forming Discs as manufactured by Pipeline Seal & Insulator, Inc, Houston, TX, or engineer pre-approved equal.
 Consideration of brands other than mentioned above shall be submitted to the Engineer for evaluation at least 10 days prior to bid due date and shall include evidence of a minimum of 25 years of successful in-service application of the mechanical seal, as well as current ISO-9001:2000 registration.



WARRANTY

All products are warranted against failure caused by manufacturing defects for a period of one year. Any product found to be so defective and returned within one year from date of shipment will be replaced without charge. The above warranty is in lieu of, and we disclaim, any and all other warranties,

expressed or implied, including the warranties of merchantability and fitness for a particular purpose, and buyer agrees to accept the products without any such warranties. We hereby disclaim any obligation or liability for consequential damages, labor costs or any other claims or liabilities of any kind whatsoever.



HOW TO ORDER

The best way to quickly and easily size Link-Seal® Modular Seals is to use the on-line Seal-Finder™ program. Just click on the adjacent logo and you'll find how easy it is to size both Link-Seal® Modular Seals and Century-Line® Sleeves.

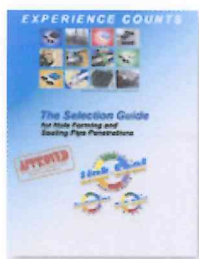

[Click here](#) for more detailed ordering instructions included in our 12 page selection guide.



[Click here](#) for even more detailed ordering instructions included in our 32 page engineering manual.

[Click here](#) for sizing charts when using Link-Seal® Modular

[Click here](#) for sizing charts when using Link-Seal® Modular

[Click here](#) for sizing charts when using Link-Seal® Modular



Seals specifically with Century-Line® Sleeves.

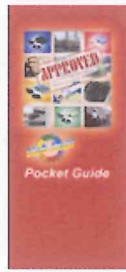

Seals specifically with WS Steel Sleeves.



Seals specifically with Cast or Core Bit Drilled Holes.



INSTALLATION INSTRUCTIONS

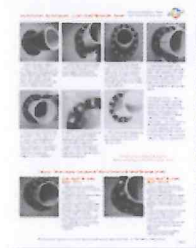

[Click here](#) for complete step-by-step instructions with photographs detailing how to install the Link-Seal® Modular Seal.



[Click here](#) for complete step-by-step instructions with photographs detailing how to install Century-Line® Sleeves.



[Click here](#) for complete step-by-step instructions with photographs detailing how to install Cell-Cast® Disks.



Pipeline Seal and Insulator, Inc.
6525 Goforth Street, Houston, TX 77021 U.S.A.
Telephone: 713-747-6948 • Toll Free: 800-423-2410
Fax: 713-747-6948 • info@psipsi.com



#1 CHOICE OF PROFESSIONALS®

SF302 Synko-Flex® Waterstop

Physical Properties

Appearance.....Black strips Hydrocarbon Content..... 50% to 70% (ASTM D4) Volatile Matter.....2.0% max. (ASTM D6) Specific Gravity.....1.20 to 1.35 (ASTM D71) Ductility.....5.0 min. (ASTM D113) Softening Point.....320°F (ASTM D36) Penetration.....50 to 120 (ASTM D217) Flash Point.....600°F min. (ASTM D92) Flow Resistance.....No Flow (Fed. Spec SSS-210) (in vertical position 5 days at 135°F) Resistance to Hydrostatic Head.....68 feet of water (on non-moving joints)	Sizes Length/strip.....3 ft. Cross section (as extruded).....1 in. x 1 in. Cross section (as installed).....5/8 in. x 1-1/2 in. Packaging No. strips per carton.....35
---	---

Approvals & Certifications

Meets Federal Specification SSS-210	Certified ANSI/NSF 61 for use in potable water systems
-------------------------------------	--

Description

SF302 Synko-Flex® Waterstop is a specially formulated non-swelling preformed joint sealant that provides a lasting, watertight bond to both fresh and cured concrete surfaces. It is a single component, self-sealing adhesive compound, extruded in a square cross-section between two quick-release protective wrappers. It bonds to cured concrete surfaces and fuses with fresh concrete during the hydration and curing process to achieve a watertight seal within cold joints at footings, walls and slabs on a wide variety of concrete structures. It does not rely on swelling to achieve its watertight seal, and therefore, it is unaffected by rain or wet conditions which may occur prior to joint completion.

Features

- Easy to install
- Eliminates split forming, wiring to rebar, heat welding of splices
- Unaffected by rain or wet conditions during installation
- Excellent chemical resistance
- Bonds to most all substrates
- Unaffected by cyclic wetting and drying
- Never a risk of fracturing concrete like swelling type waterstops
- Safe for use in potable water structures

SF302 Synko-Flex® Waterstop

Uses

SF302 Synko-Flex® Waterstop is designed to provide a watertight seal of cold joints in a wide range of concrete structures including: residential and commercial basements, secondary containment structures, highway tunnels, concrete lined storm drainage and irrigation channels, pedestrian tunnels and below-grade walkways, swimming pools and water features, below-grade parking garages, waste-water treatment plants, fish hatcheries and aquariums, potable water reservoirs, and water theme parks. **SF302 Synko-Flex® Waterstop** may also be used to seal around concrete, steel, PVC, or HDPE pipe penetrations through concrete walls or floor slabs. **SF302 Synko-Flex® Waterstop** is also ideal for use as a joint sealant on precast structures such as box culverts, septic tanks and utility vaults.

Surface Preparation

Joint surfaces should be clean and dry before priming and just prior to placing the **SF302 Synko-Flex®** strips. Concrete should cure a minimum of 24 hours prior to priming. Ensure that concrete surfaces are free from form oils, release agents, curing compounds, laitance and other dirt or debris. Use a wire brush or stiff bristle brush to clean surface prior to priming.

Application

Positioning: **SF302 Synko-Flex® Waterstop** is generally positioned in the center of the joint. It may be placed at the bottom of a keyway, if a keyway is incorporated into the joint design. However, a keyway is not required for the use of this product. Two inches of concrete coverage is recommended.

Standard Method: Apply **SF302 Synko-Flex® Primer** to the cured surface and allow to dry. Drying time generally takes 2 to 3 hours. Drying time will take longer in low temperatures and in humid environments.

Peel the protective release paper from one side of the **Synko-Flex®** strip. Place the strip onto the primed surface pressing firmly along the entire length of the strip. The strip should be depressed to approximately 5/8 inch in thickness forcing it to widen to approximately 1-1/2 inches. Splice strips together with a 1-inch overlap or side lap. Remove the remaining release film. Fresh concrete may then be poured directly against the **Synko-Flex®**. The waterstop sealing system is complete when the fresh concrete cures.

In cold weather, both the **Synko-Flex®** strips and the concrete surface should be warmed just prior to application.

Alternate Application Method: **Synko-Flex®** may also be installed directly in the fresh concrete.

Horizontal Applications: Peel the protective release paper from one side of the **Synko-Flex®** strip. While concrete is still wet, carefully press the **Synko-Flex®** strips into the fresh concrete, leaving approximately 1/2 inch exposed above the concrete surface. When concrete cures, remove remaining release film, and continue with pour.

Vertical Applications: Peel off release paper from one side of the strip, leaving the polyethylene release film on the formwork side of the **Synko-Flex®** to prevent the **Synko-Flex®** from adhering to the formwork and to keep the **Synko-Flex®** clean once the forms are removed. The **Synko-Flex®** is then nailed to the inside of the concrete form using small finishing nails. Chamfer strips (1/2") should be positioned on each side of the **Synko-Flex®** strip. Finishing nails will pull through the **Synko-Flex®** strips when end form is removed.

Limitations: **Synko-Flex®** is designed for use in non-moving or reinforced joints. Contact manufacturer regarding applications where limited movement could be expected.

REVISION: 01/24/12

SF302 Synko-Flex® Waterstop

Caution

FLAMMABLE! Use caution around open flame. Do not heat container or store at temperatures greater than 120°F. DO NOT TAKE INTERNALLY! Use protective measures to avoid contact with eyes and skin. **If swallowed, CALL PHYSICIAN IMMEDIATELY. In case of eye contact, open eyelids wide and flush immediately with plenty of water for at least 15 minutes. GET MEDICAL ATTENTION!**

**KEEP OUT OF REACH OF CHILDREN
DO NOT ALLOW PRODUCT TO FREEZE**

Warning: This product contains detectable amounts of chemicals known to the State of California to cause cancer, or birth defects or other reproductive harm.

Employers should obtain a copy of the **Material Safety Data Sheet (MSDS)** from your supplier or directly from Henry at the toll free number or website below.

Limited Warranty

Specifications and other information contained herein supersede all previously printed matter and are subject to change without notice. All goods sold by the seller are warranted to be free from defects in material and workmanship and meet the physical and chemical requirements of Federal Specification SSS-210. The foregoing warranty is in lieu of and excludes all other warranties not expressly set forth herein, whether express or implied by operation of law or otherwise, including but not limited to any implied warranties of merchantability or fitness. Seller shall not be liable for incidental or consequential losses, damages or expenses, directly or indirectly arising from the sale, handling or use of the goods, or from any other cause relating thereto, and seller's liability hereunder in any case is expressly limited to the replacement (in the form originally shipped) of goods not complying with this agreement or at seller's election, to the repayment of, or crediting buyer with, an amount equal to the purchase price of such goods, whether such claims are for breach of warranty or negligence. Any claim by buyer with reference to the goods sold hereunder for any cause shall be deemed waived by buyer unless submitted to seller in writing within 30 days from the date buyer discovered or should have discovered any claimed breach.

Statement of Responsibility

The technical and application information herein is based on the present state of our best scientific and practical knowledge. As the information herein is of a general nature, no assumption can be made as to a product's suitability for a particular use or application and no warranty as to its accuracy, reliability or completeness either expressed or implied is given other than those required by law. The user is responsible for checking the suitability of products for their intended use. Henry Company data sheets are updated on a regular basis; it is the user's responsibility to obtain and to confirm the most recent version. Information contained in this data sheet may change without notice.

REVISION: 01/24/12

LEGEND

- ① SPANKO-FLEX
- ② HARD PIPE OR CONDUIT
- ③ GALV. SLEEVE
- ④ LINK-SEAL
- ⑤ WEEP RING
- ⑥ HYDRO-PHILIC MATERIAL (LOW EXPANSION RATIO)

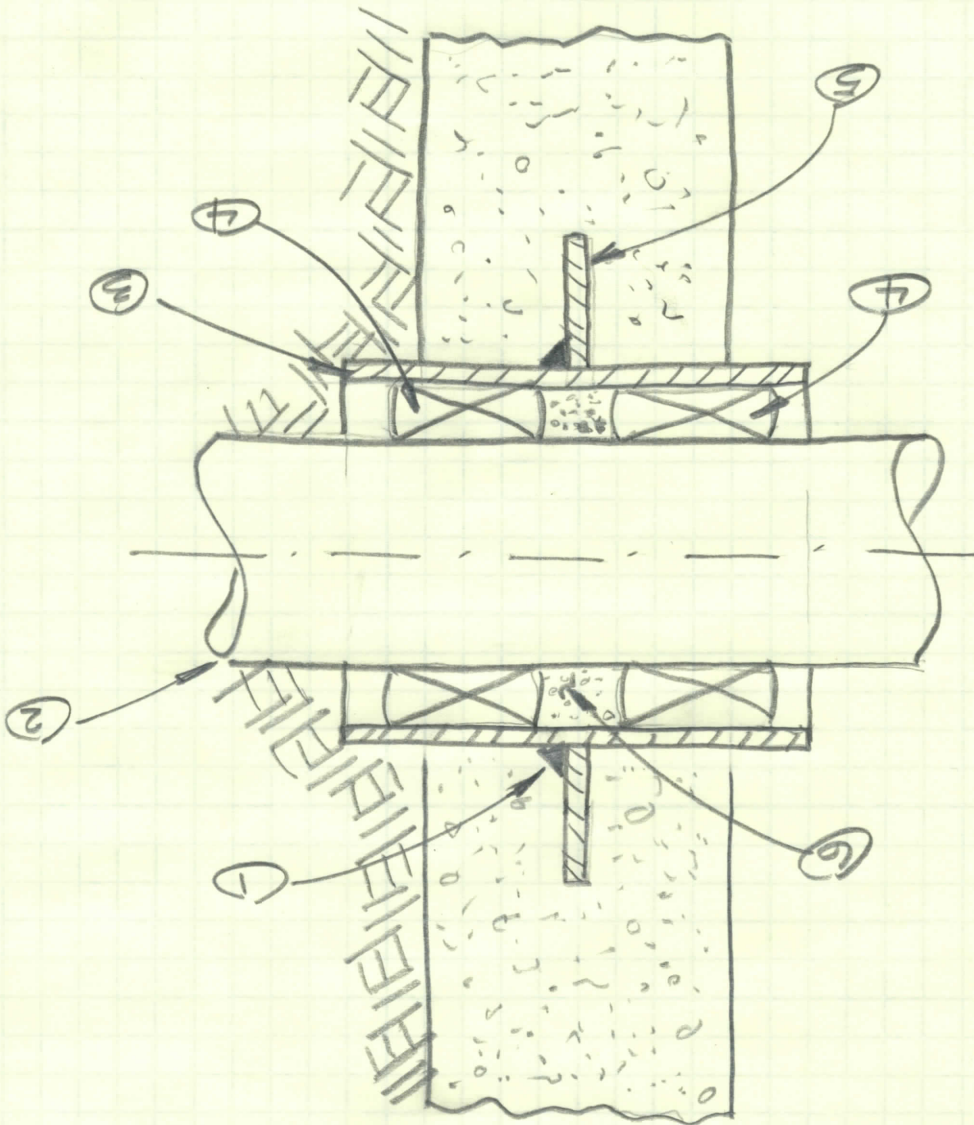

TYPICAL DOMESTIC WATER FEED TO BLDG.

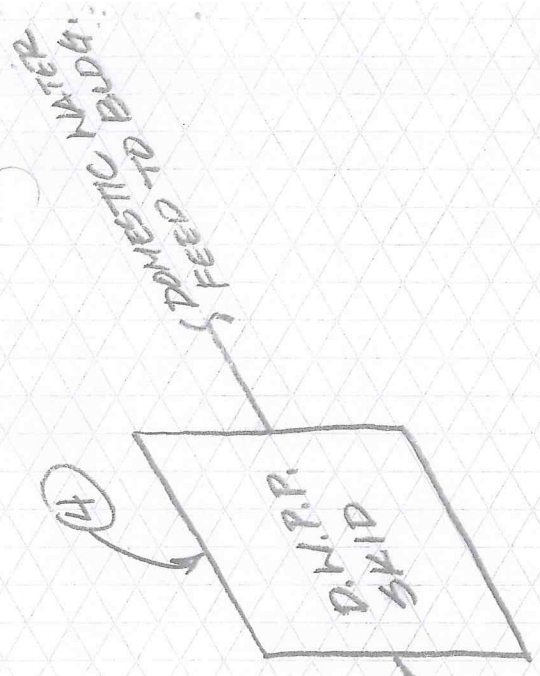

LEGEND

- ① ISOLATION VALVE
- ② REMOVABLE SPOOL (SEE DETAIL)
- ③ BACK-FLOW PREVENTER ASSY
- ④ DOMESTIC WATER PUMP SKID (SEE DETAIL)
- ⑤ PRESS. GAUGE ASSY. (SEE DETAIL)
- ⑥ WALL PENETRATION (SEE WALL PEN. DETAIL)
- ⑦ UTILITY WATER METER DUAL ELEMENT COMBO METER OR MAG. METER

FROM DOMESTIC WATER PROVIDER

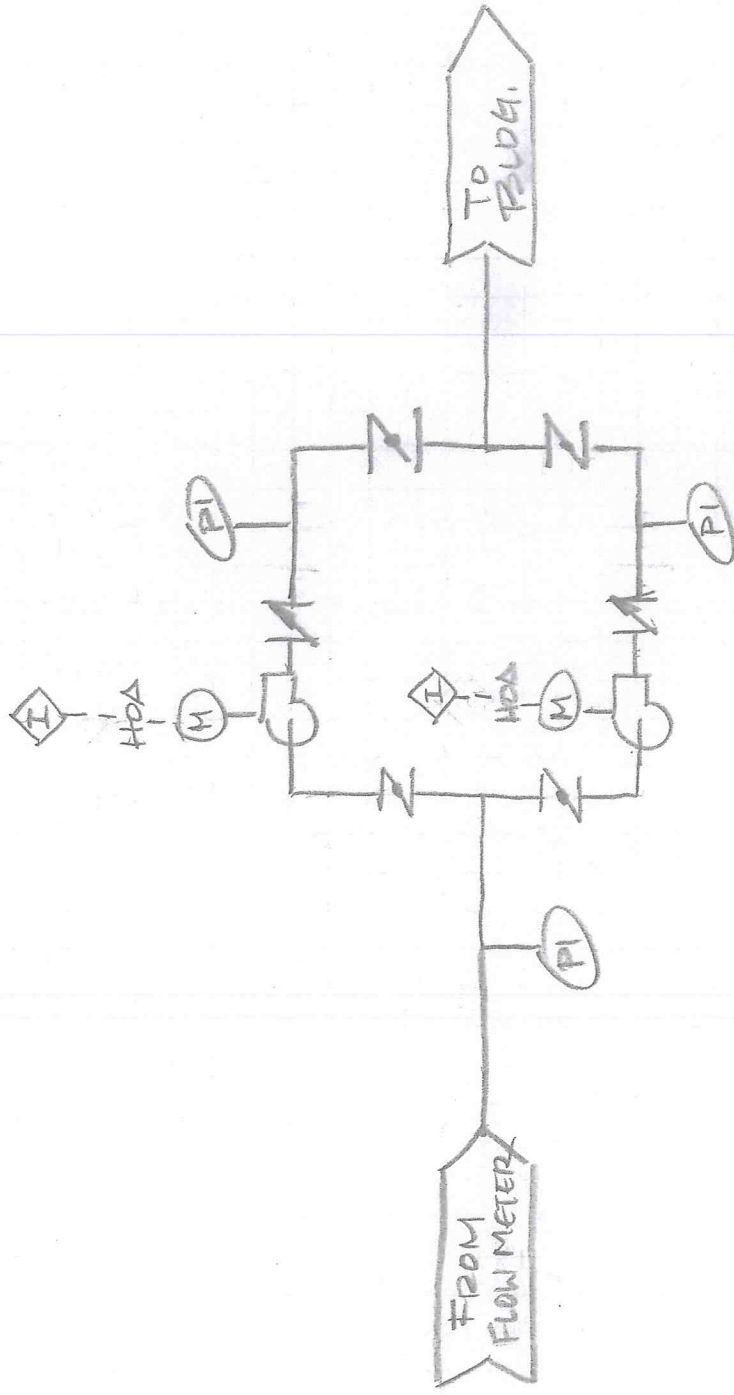

V.F.D. -
CONTROLLED BASED
HIGH POINT PRESSURE.

① : BAS + LEAD/LAG

D.W.P.P.

LATER METER RUN

TEMP.

HOT WATER
 CHH WATER
 DOM. WATER

COOLING TOWER MAKE-UP
 COOLING TOWER BLOWDOWN

DOMESTIC
 WATER
 FROM
 BACKFLOW
 PREVENTER

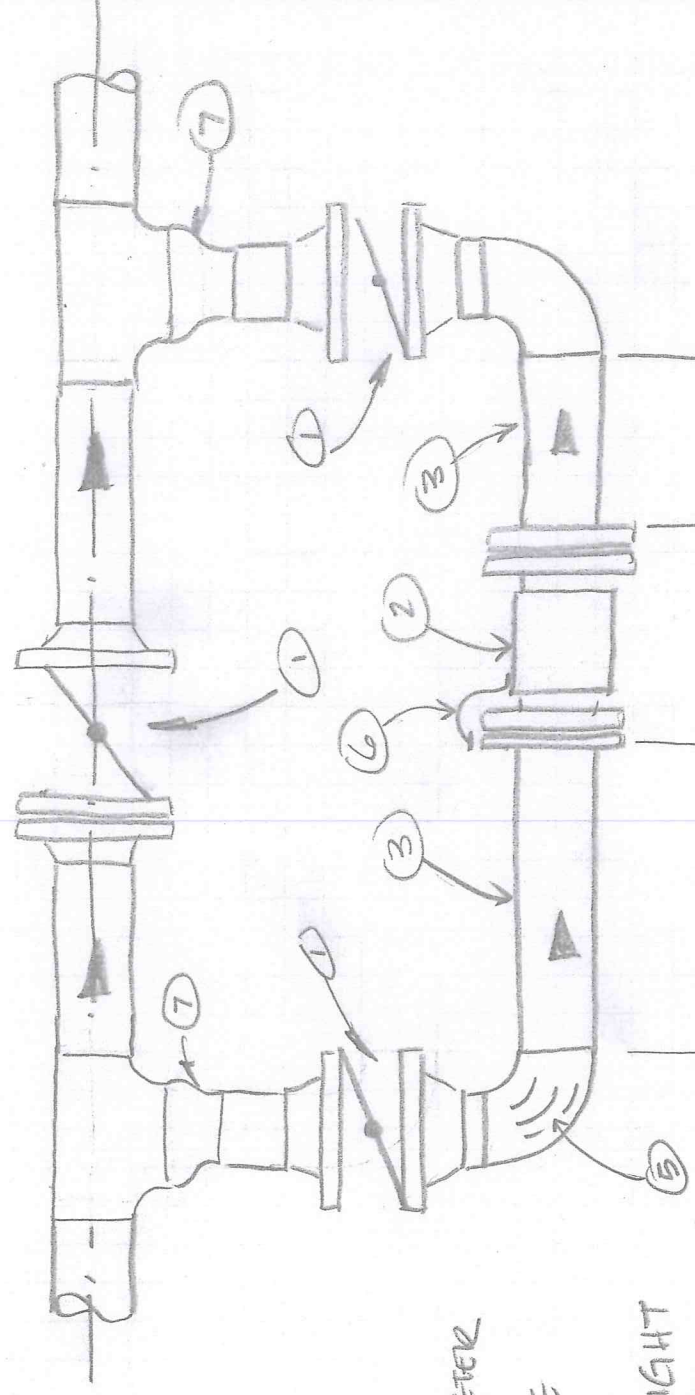

LEGEND

- ① BUTTERFLY VALVE
- ② FULL THROAT MAG METER
- ③ INSTRUMENT GRADE SEAMLESS PIPE.
- ④ LENGTH OF STRAIGHT RUN DEPENDENT PIPE DIAMETER & # OF PLANE CHANGES UPSTREAM OF METER.
- ⑤ IF NECESSARY STRAIGHTENING YANES ARE ACCEPTABLE
- ⑥ GRINDING STRAP REQ. ON ALL MAG. METERS.
- ⑦ CONC. REQ. IF NECESSARY.

MIN. REQ. LENGTH RATIO 4 : 100 (UPSTREAM) ④

MIN. REQ. LENGTH + 100 (DOWNSTREAM) ④

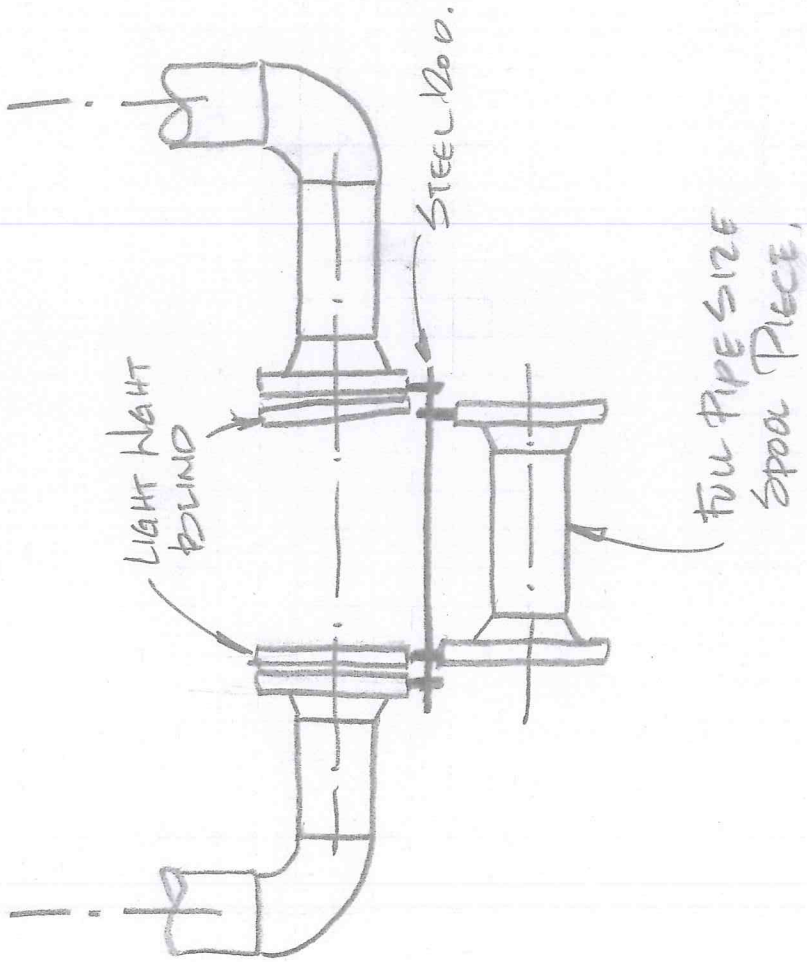

SPOOL PIECE DETAIL

LOW LEAD METER WITH ORION HEADS HIGH & LOW

Recordall® Compound Series Meter	Cold Water Size 6" (DN 150 mm)	Technical Brief
---	-----------------------------------	----------------------------

BACNET

DESCRIPTION

APPLICATIONS: For use in measurement of potable cold water in commercial and industrial services where flow is in one direction only.

OPERATION: At low flow rates, the water is diverted up through a bypass to the disc chamber. Leaving the chamber's outlet port, water flows beyond the turbo and main valve. As the flow rate increases, a pressure differential is created which opens the main valve. The water then flows straight through the turbine chamber in addition to a portion still flowing through the disc chamber before exiting the meter. Rotor and disc movement are transmitted by magnetic drive couplings to individual register odometers.

OPERATING PERFORMANCE: The Badger® Recordall Compound meter meets or exceeds registration accuracy for low flow rate, normal operating flow rates, maximum continuous operation flow rate, and changeover flow rate as specifically stated in AWWA Standard C702.

CONSTRUCTION: Badger Recordall Compound meter construction which complies with ANSI and AWWA C702 standards, consists of three basic components: meter housing, interchangeable measuring elements and single, sealed direct reading registers. The measuring element consist of the disc measuring chamber, turbo head assembly and high flow valve assembly.

To simplify maintenance, the registers and measuring elements can be removed without removing the meter housing from the installation.

MAGNETIC DRIVE: Direct magnetic drive, through the use of high-strength magnets, provides positive, reliable and dependable register coupling for straight-reading or remote reading options.

SEALED REGISTERS: The standard registers consists of a straight-reading odometer-type totalization display, 360° test circle with center sweep hand and flow finder to detect leaks. Register gearing consists of self-lubricating thermoplastic gears to minimize friction and provide long life. Permanently sealed; dirt, moisture, tampering and lens fogging problems are eliminated. Multi-position register simplifies meter installation and reading. Automatic meter reading and close proximity systems are available for all Compound Series meters. (See back of sheet for additional information.) All reading options are removable from the meter without disrupting water service.

METER READING TECHNOLOGIES: The Itron® ERT®, ORION® and TRACE® meter reading systems are available for all Recordall Compound Series meters. An optional summator or Read-o-Matic® summator/converter can be provided as an integral part of the register assembly. (See back of sheet for additional information.)

TAMPER-PROOF FEATURES: Tamper resistant register provides protection from unauthorized personnel.

STRAINER: A separate strainer is recommended to protect the measuring element but is not a requirement. See Technical Brief PS-T-1 for strainer dimensions.

MAINTENANCE: Badger Recordall Compound meters are designed and manufactured to provide long-term service with minimal maintenance.

When maintenance is required, it can be performed easily either at the meter installation or at any other convenient location. As an alternative to repair by the utility, Badger offers various maintenance and meter component exchange programs to fit the needs of the utility.

CONNECTIONS: Companion flanges for installation of meters on various pipe types and sizes are available in cast iron or bronze as an option.

STANDARD: 3/4" drain plug.

RTR®, Badger®, Read-o-Matic®, ORION® and Recordall® are registered trademarks of Badger Meter, Inc.; TRACE® is a registered trademark of American Meter Company. Itron® and ERT® are registered trademarks of Itron, Inc.

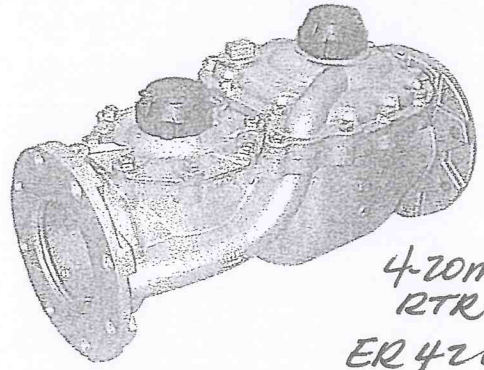

MIKE BEACH

4-20MA
RTR
ER 420.

SPECIFICATIONS

Typical Operating Range (100% ± 1.5%)	3/4-2000 GPM (0.17 to 454.4 m³/h)
Low Flow Registration	3/8 GPM (0.09 m³/h)
Maximum Continuous Flow	1500 GPM (340.5 m³/h)
Pressure Loss at Maximum Continuous Flow	9.3 PSI at 1500 GPM (0.64 bar at 340.5 m³/h)
Pressure Loss at Crossover	5 PSI (0.35 bar)
Minimum Crossover Accuracy	95%
Maximum Operating Pressure	150 PSI (10 bar)
Maximum Operating Temperature	120°F (49°C)
Meter Flanges	6" Round Flanges, Class 150
Registers	Straight reading, permanently sealed magnetic drive standard. Automatic Meter Reading and Close Proximity units optional.
High Flow Registration	1,000,000,000 Gallons 1,000 gallons/sweep hand revolution. 100,000,000 Cubic Feet 100 cubic ft./sweep hand revolution. 1,000,000 m³ 1 m³/sweep hand revolution.
Low Flow Registration	100,000,000 Gallons 10 gallons/sweep hand revolution. 10,000,000 Cubic Feet 1 cubic ft./sweep hand revolution. 100,000 m³/sweep hand revolution. .1 m³/sweep hand revolution.

MATERIALS

Housing	Cast Bronze
Nose Cone and Straightening Vanes	Thermoplastic
Rotor	Thermoplastic
Rotor Radial Bearings	Lubricated Thermoplastic
Rotor Thrust Bearing	Sapphire Jewels
Rotor Bearing Pivots	Passivated 316 Stainless Steel
Calibration Mechanism	Stainless Steel And Thermoplastic
Measuring Chamber and Disc	Thermoplastic
High Flow Valve	Thermoplastic / Stainless Steel
Magnets	Ceramic
Register Lens	Glass
Register Housing and Cover	Thermoplastic or Bronze
Trim	Stainless Steel



BadgerMeter, Inc.

RCS-T-6

Automatic Meter Reading Systems

AMR

The Itron®, ORION®, and TRACE®, radio frequency systems easily integrate with all Recordall® Compound Series meters. All technologies provide an efficient meter data retrieval and information management system. The Itron 50W ERT®, ORION Transmitter and the TRACE Transponder all connect to the Recordall Transmitter Register (RTR®) assembly. Complete systems, including hardware and software, are available to provide a wide range of meter reading information.

PRESSURE LOSS CHART

Rate of Flow, in Gallons per Minute

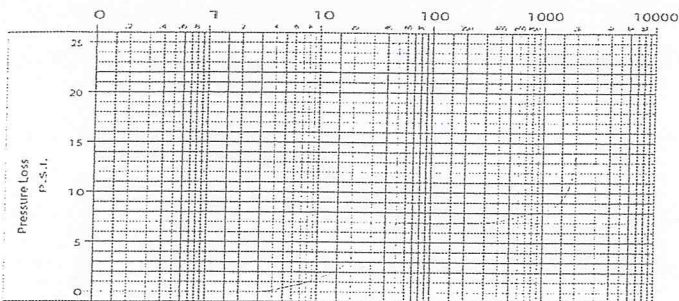

ACCURACY CHART

Rate of Flow, in Gallons per Minute

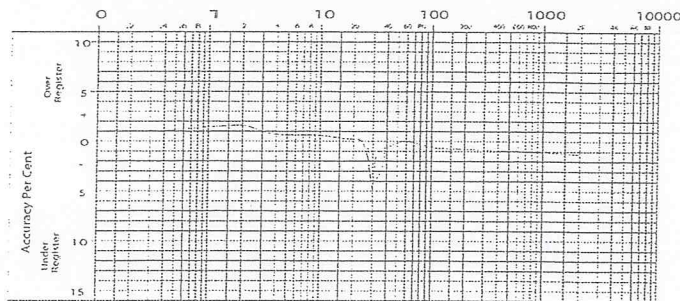

Meter & Pipe Size	DIMENSIONS								
	Length A	Width B	Height C	Flange D	Bolt Circle E	Centerline to F Base	No. Bolts	Net Weight	Shipping Weight
6" (DN 150)	24" (610mm)	12 3/8" (314mm)	8 7/8" (225mm)	1" (25mm)	9 1/2" (241mm)	5 3/8" (137mm)	8	152 lb. (68.7kg)	200 lb. (90.4kg)

PROPER INSTALLATION: The following installation guidelines will insure optimum field performance and reliability when installing a Badger® Compound Series meter.

1. A Strainer IS REQUIRED to insure optimum flow conditioning and protection for the Compound Series meter measuring element.
2. Compound meters, with a strainer, REQUIRE a minimum of five (5) pipe diameters of straight pipe upstream of the meter.
3. ONLY full-open gate valves should be used immediately upstream of the meter. Butterfly valves MUST be five (5) pipe diameters or more upstream of the meter. Full-open gate or butterfly valves can be used downstream.
4. DO NOT install pressure reducing devices or check valves upstream of the meter.
5. Unweighted check valves MUST be located at least three (3) pipe diameters downstream of the meter.
6. Pressure reducing devices and externally weighted check valves MUST be located at least five (5) pipe diameters downstream of the meter.

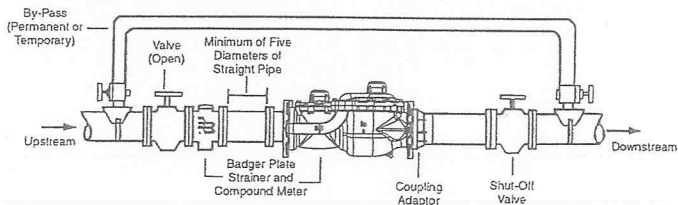
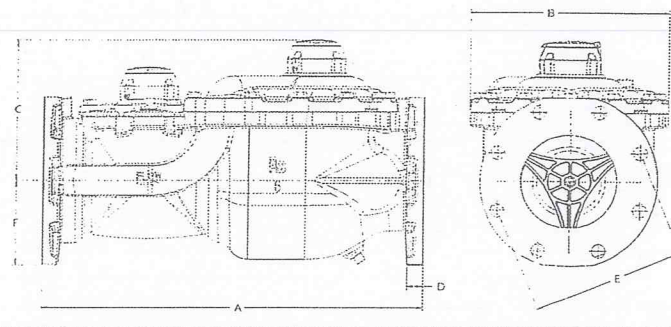

LOW FLOW

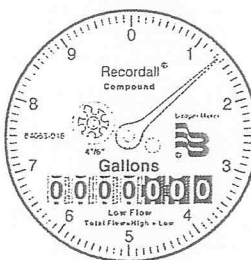

HIGH FLOW

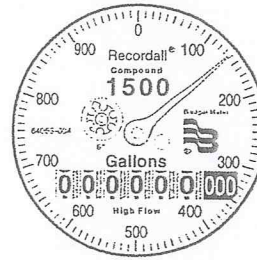

Please see our website at www.badgermeter.com for specific contacts.

Due to continuous research, product improvements and enhancements, Badger Meter reserves the right to change product or system specifications without notice, except to the extent an outstanding bid obligation exists.



Badger Meter, Inc.

P.O. Box 245036, Milwaukee, WI 53224-9536
 (800) 876-3837 / Fax: (888) 371-5982
www.badgermeter.com



Badger Meter

Recordall®

Transmitter Register (RTR)

DESCRIPTION

APPLICATIONS: The Recordall® Transmitter Register (RTR®) is designed for use with all Recordall Disc, Turbo, Compound and Fire Service Meters to provide output compatibility with ORION®, GALAXY, Itron® ERT®, and Badger Meter, Inc. approved AMR technology solutions.

RESOLUTION: Digital output from the RTR typically has resolution of 1/10th of the register test circle (resolution may vary in some cases). The electronic resolution table in this brochure lists minimum output resolution for all Recordall meter applications.

MOUNTING: The RTR in its shroud assembly uses a bayonet mount compatible with all Recordall Disc and Turbo meters. A TORX® seal screw is provided to allow positioning of the register for the most convenient reading and to secure the register to the meter body in a tamper resistant mode. The RTR can be removed from the meter without disrupting water service.

MAGNETIC DRIVE: Direct drive high-strength magnetic coupling through the meter body to the wetted magnet provides reliable and dependable register coupling.

SEALED REGISTER: The RTR local register consists of a six-digit straight-reading mechanical odometer totalizer (located in the six o'clock position), a 360° test circle with sweep hand, and a flow finder to detect leaks. The register gearing is self-lubricating thermoplastic to minimize friction and provide long, reliable life. Permanent sealing eliminates moisture, dirt, and other contaminants. The leak rate of the seal is less than 10-6 cc/sec as tested by a helium mass spectrometer.

TAMPER-PROOF FEATURES: Customer removal of the RTR can be prevented by using a tamper resistant TORX seal screw. TORX seal screws are provided as standard accessories with the RTR. Optional tamper detection seal wire screws are also available.

CONSTRUCTION: The housing of the RTR is constructed of a strengthened glass lens top and a corrosion-resistant metal bottom. Internal construction materials are thermoplastics for long-life and high reliability. The integrity of the adhesive seal joining the glass top to the metal base provide unmatched protection in water meter applications. A corrosion and tamper resistant TORX seal screw is provided to secure the RTR to the meter. The shroud assembly is thermoplastic.

TEMPERATURE: The operating range of the RTR is -40...49° C (-40...120° F). The water meter should not be subjected to temperatures below freezing.

MOISTURE: The RTR achieves true water resistance due to the adhesive technology used in the sealing process. Leak rates less than 10-6 cc/sec, as tested by a helium mass spectrometer, are comparable to a true hermetic seal. Due to this unique sealing process, the RTR exceeds all applicable requirements of AWWA Standard C707 regarding moisture intrusion. Register fogging and condensation are no longer an issue.

WIRE CONNECTIONS: The RTR is provided as either a factory prewired assembly or as a register with pre-sized wire harness available for connection in the field.

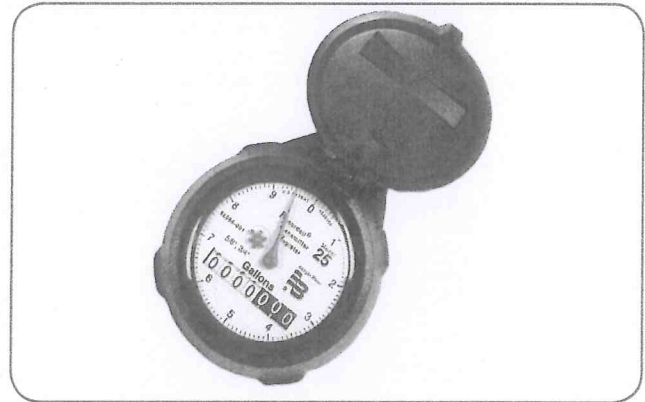

SPECIFICATIONS

Transmitter/Register	Straight reading, permanently sealed, magnetic drive
Unit of Measure	U.S. gallons, cubic feet, cubic meters, clearly identified on register face
Number Wheels	Six with 3/16" high numerals font type
Test Circle	360° circle with ten major increments with ten divisions each
Weight	9 ounces
Humidity	0...100% condensing
Temperature	-40...49° C (-40...120° F)
Signal Characteristics	Open Drain (FET)
Visual Resolution	1/100th of Test Circle
Electronic Resolution	1/10th of Test Circle
Typical Signal Duration	15...75 ms @ 25° C (77° F) 8...75 ms over operating temperature range at 67 µA
On State Resistance	7.5 Ohms @ 25° C (77° F)
Power Source	External
Maximum Switching	30V DC @ 1 mA @ 25° C (77° F)

ELECTRONICS: The piezoelectric switch circuit board is completely sealed against moisture inside the unit and sealed to ensure protection from humidity.

ELECTRICAL: The electronic circuitry is designed to provide immunity to electrical surges and transients per IEC801-2, IEC801-4 Severity Level 4.

OPERATING CHARACTERISTICS: The RTR has an output equal to 1/10th of the meter test circle with the characteristics of an open drain FET. The on-state condition is a solid-state switch closure. Off-state condition is an open circuit. Powered by an external source, the RTR has a maximum rating of 30V DC at 1 mA (25° C).

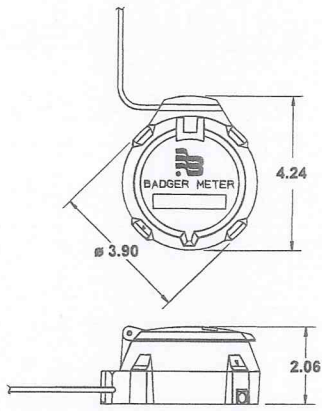

Dimensional Drawing



RTR Register

MEASUREMENT RESOLUTION: The minimum electronic resolution of the RTR is as noted below. To verify the correct resolution for your application, contact your Badger Meter regional sales office.

RECORDALL Disc Series	Size	Resolution Gallons	Resolution Cubic Feet (ft ³)	Resolution Cubic Meters (m ³)
M25	5/8"	1	0.1	0.01
M25	3/4"	1	0.1	0.01
M35	3/4"	1	0.1	0.01
M40	1"	1	0.1	0.01
M55	1"	1	0.1	0.01
M70	1"	1	0.1	0.01
M120	1-1/2"	10	1	0.1
M170	2"	10	1	0.1

RECORDALL Turbo Series	Resolution Gallons	Resolution Cubic Feet (ft ³)	Resolution Cubic Meters (m ³)
1-1/2"	100	10	0.1
2"	100	10	0.1
3"	100	10	0.1
4"	100	10	0.1
6"	100	10	1
8"	100	10	1
10"	100	10	1
12"	1000	100	1
16"	1000	100	10
20"	1000	1000	10

IMPORTANT

The RTR® should only be connected to a Badger Meter, Inc. approved product. Connection to an unapproved product will void the RTR warranty.

Fire Service Meters	Resolution Gallons	Resolution Cubic Feet (ft ³)	Resolution Cubic Meters (m ³)
3"	100	10	0.1
4"	100	10	0.1
6"	100	10	1
8"	100	10	1
10"	100	10	1

RECORDALL Compound Series	Resolution Gallons	Resolution Cubic Feet (ft ³)	Resolution Cubic Meters (m ³)
2"	100	10	0.1
3"	100	10	0.1
4"	100	10	0.1
6"	100	10	1

Resolution stated as summed total with (2) RTRs, Summator/ Splitter and a single AMR module. Please see the Turbo Series and Disc Series sections for individual high and low side resolution.

Fire Series Assemblies (FSA)	Resolution Gallons	Resolution Cubic Feet (ft ³)	Resolution Cubic Meters (m ³)
4"	100	10	0.1
6"	100	10	1
8"	100	10	1
10"	100	10	1

Resolution stated as summed total with two RTRs, Summator/ Splitter and a single AMR module. Please see the Turbo Series and Disc Series sections for individual mainline and by-pass resolution.